

MW Order No. :DC PLUG-P1J-R6B

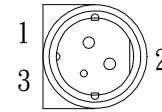

Pin Assignmet

P1J+ connected to R6B P1、3 (+)
 P1J- connected to R6B P2 (-)

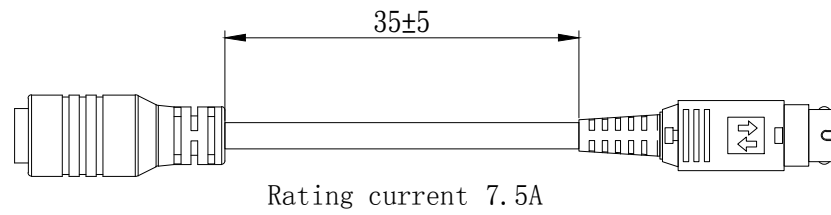
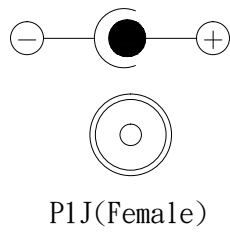

OC02WK0001

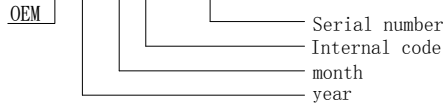

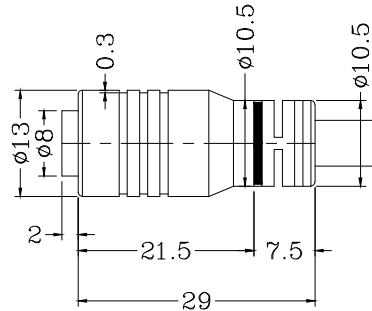

0:OEM
 C0:2020 (A:0, B:1, C:2)
 2:February(A:10, B:11, C:12)
 WK:Internal code
 0001:Serial number

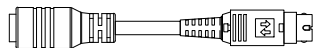

Remark:
 1.30pcs per packing

PACKAGING BAG

MW' s Order NO.	DC PLUG-P1J-R6B
Specification	Straight P1J(2.1*5.5*11mm) → 3pin din R6B (KYCON KPPX-3P equivalent)  R6B P1、3 (+) R6B P2 (-)
Quantity	1 pc
Bar code	 OC02WK0001



明緯企業股份有限公司
 MEAN WELL ENTERPRISES CO., LTD.

ITEM DC PLUG CONVERTER