



Test Report: RST-10000-48

10000W Single Output Power Supply

DESIGN VERIFY TEST

Output Function Test

Input Function Test

Protection Function Test

Control Function Test

Component Stress Test

SAFETY & E.M.C. TEST

Safety Test

E.M.C. Test

RELIABILITY TEST

ENVIRONMENT TEST

OUTPUT FUNCTION TEST

| NO | TEST ITEM | SPECIFICATION | TEST CONDITION | RESULT |
|----|-----------------------------|-----------------------|---|---|
| 1 | OUTPUT VOLTAGE ADJUST RANGE | CH1:47 V~57.6 V | I/P:230VAC(Δ) I/P:400VAC(Y) O/P:MIN. LOAD Ta:25°C | 60.50V~45.11V /230VAC(Δ) 60.50V~45.10V/400VAC(Y) |
| 2 | OUTPUT VOLTAGE TOLERANCE | V1: -1%~ 1% (Max) | I/P: 196VAC /305VAC(Δ) I/P:340VAC /530VAC(Y) O/P: FULL LOAD / MIN. LOAD Ta:25°C | V1:0%~-0.27%(Δ) V1: 0%~-0.29%(Y) |
| 3 | LINE REGULATION | V1: -0.5%~ 0.5% (Max) | I/P: 196VAC~ 305VAC(Δ) I/P: 340VAC~ 530VAC(Y) O/P: FULL LOAD / MIN. LOAD Ta:25°C | V1:0 %~0%(Δ) V1:0 %~0%(Y) |
| 4 | LOAD REGULATION | V1: -0.5%~ 0.5% (Max) | I/P: 230VAC(Δ) I/P:400VAC(Y) O/P:FULL ~MIN LOAD Ta:25°C | V1:-0.04%~0.23%(Δ) V1:-0.06 %~0.22%(Y) |
| 5 | RIPPLE & NOISE | V1: 200mVp-p (Max) | I/P:230VAC(Δ) I/P:400VAC(Y) O/P:FULL LOAD Ta:25°C | V1: 125 mVp-p(Δ) V1: 120 mVp-p (Y) |

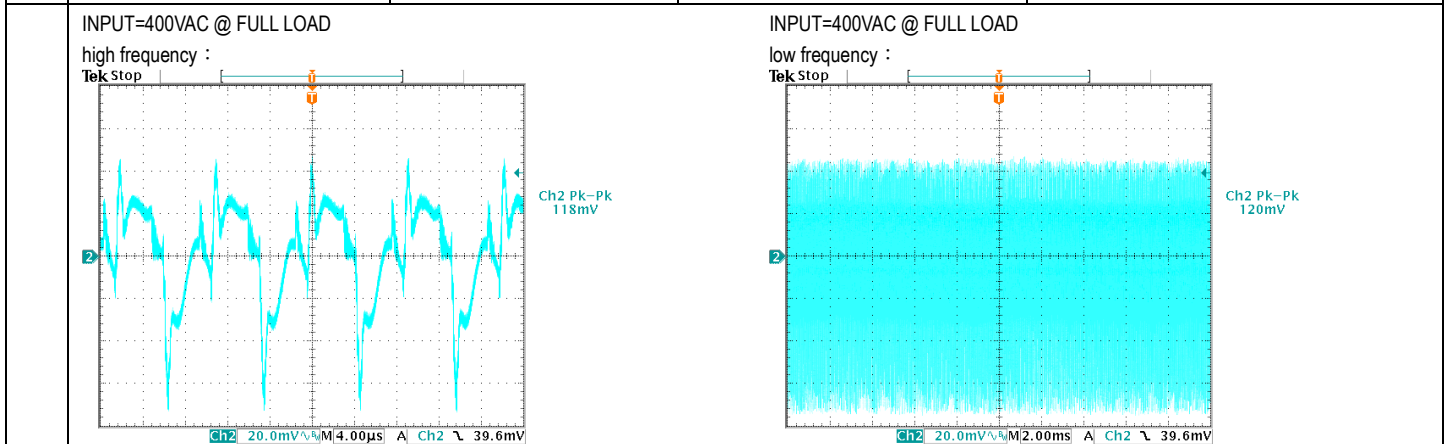

| | | | | |
|---|-------------|--|---|--|
| 6 | SET UP TIME | 230VAC/2200ms (Max) 400VAC/2200ms (Max) | I/P: 230VAC(Δ) 400VAC(Y) O/P:FULL LOAD Ta:25°C | 230VAC/1820 ms(Δ) 400VAC/ 1800ms(Y) |
|---|-------------|--|---|--|

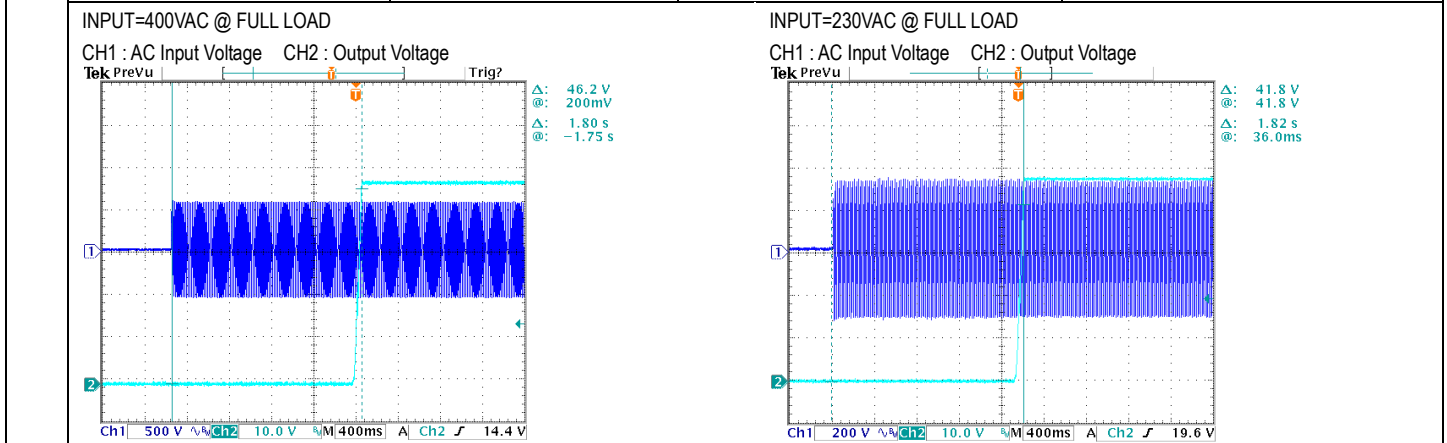



10000W Single Output Power Supply

RST-10000 series

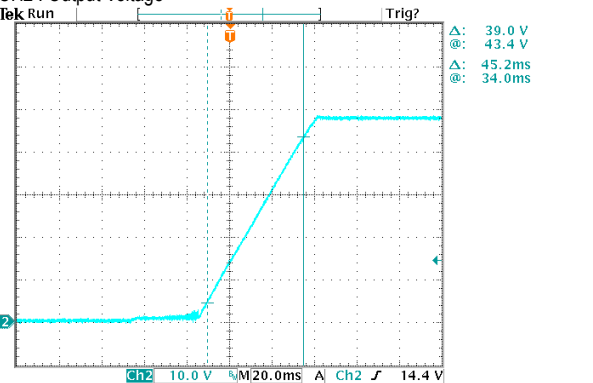
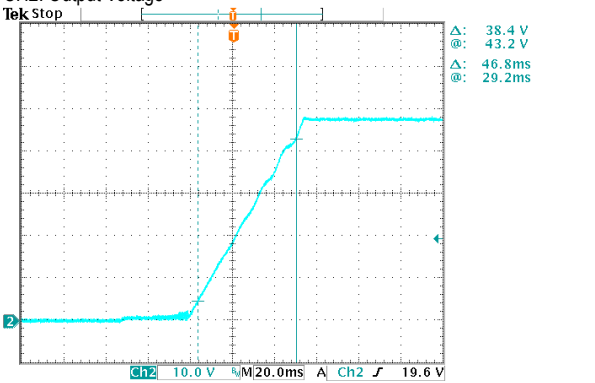
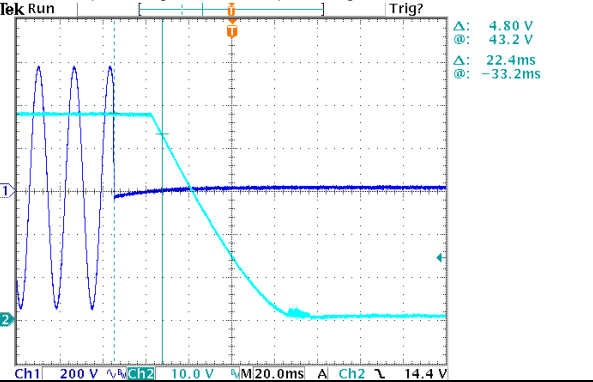
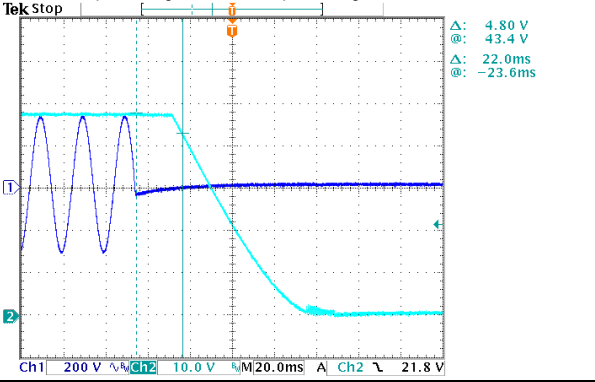
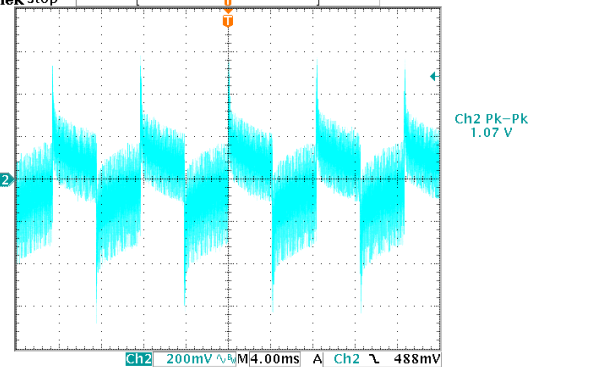
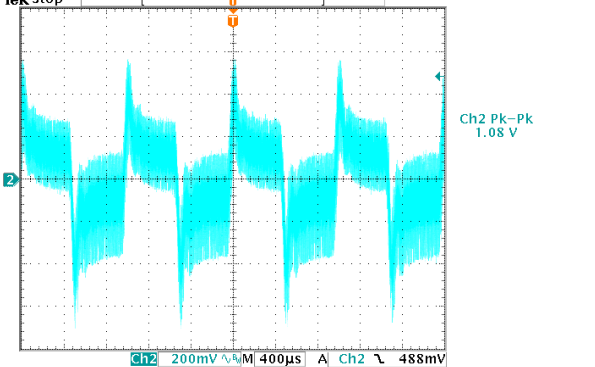
| | | | | |
|--|--------------|---|---|--|
| 7 | RISE TIME | 230VAC/80ms (Max) 400VAC/80ms (Max) | I/P: 230VAC(Δ) I/P: 400VAC(Y) O/P: FULL LOAD Ta:25°C | 230VAC/46.8 ms(Δ) 400VAC/ 45.2ms(Y) |
| INPUT=400VAC @ FULL LOAD CH2 : Output Voltage  | | INPUT=230VAC @ FULL LOAD CH2: Output Voltage  | | |
| 8 | HOLD UP TIME | 230VAC/ 14ms (Typ.) 400VAC/ 14ms (Typ.) 230VAC/ 20ms (Typ.) 400VAC/ 20ms (Typ.) | I/P: 230VAC(Δ) FULL LOAD I/P:400VAC(Y) FULL LOAD I/P: 230VAC(Δ) 75% LOAD I/P:400VAC(Y) 75% LOAD Ta:25°C | 230VAC(Δ)/22ms 400VAC(Y)/22.4ms 230VAC(Δ)/29.4ms 400VAC(Y)/29.4ms |
| INPUT=400VAC @ FULL LOAD CH1 : AC Input Voltage CH2 : Output Voltage  | | INPUT=230VAC @ FULL LOAD CH1 : AC Input Voltage CH2 : Output Voltage  | | |
| 9 | DYNAMIC LOAD | V1:4800 mVp-p | I/P: 400VAC(Y) / 230VAC(Δ) O/P: (1).FULL /50% LOAD 50%DUTY / 120HZ (2).FULL /50% LOAD 50%DUTY / 1KHZ | (1).1070mVp-p @400VAC 1080mVp-p @230VAC (2).1080mVp-p @400VAC 1210mVp-p @230VAC |
| (1).400VAC FULL /50% LOAD 50%DUTY / 120HZ  | | (2).400VAC FULL /50% LOAD 50%DUTY / 1KHZ  | | |



INPUT FUNCTION TEST

| NO | TEST ITEM | SPECIFICATION | TEST CONDITION | RESULT | | | | | | | | | | | | | | | | | | | | | | | | | | | | | | | |
|----------|-----------------------|--|---|---|--|----------|------------|------------|-----|------|------|-----|------|------|-----|------|------|-----|------|------|-----|------|------|-----|-------|-------|-----|------|------|-----|-------|-------|-----|-------|-------|
| 1 | INPUT VOLTAGE RANGE | 3Phase 3 Wire 196VAC~305VAC 3Phase 4 Wire 340VAC~530VAC | I/P: TESTING O/P: FULL LOAD Ta: 25°C | 188.79V~305 V(Δ) 323.7V~530V(Y) | | | | | | | | | | | | | | | | | | | | | | | | | | | | | | | |
| | | | I/P: (1) LOW-LINE-3V=193(Δ) / 337V(Y) HIGH-LINE+5V=305(Δ) / 535V(Y) O/P: FULL/MIN LOAD ON: 30 Sec OFF: 30 Sec 10MIN (2) 230(Δ)/400Vac(Y) ON: 0.5 Sec OFF: 0.5 Sec 20MIN (3) 230(Δ)/400Vac(Y) ON: 3Sec OFF: 3Sec 12HOURS (AC POWER ON/OFF NO DAMAGE) | TEST: OK | | | | | | | | | | | | | | | | | | | | | | | | | | | | | | | |
| 2 | INPUT FREQUENCY RANGE | 47HZ ~63 HZ NO DAMAGE OSC | I/P: 196 VAC ~305 VAC(Δ)/340~530VAC(Y) O/P: FULL-MIN LOAD Ta: 25°C | TEST: OK | | | | | | | | | | | | | | | | | | | | | | | | | | | | | | | |
| 3 | POWER FACTOR(TYP) | 0.95 / 230VAC(Δ) 0.95 / 400VAC(Y) | I/P: 230 VAC(Δ) I/P: 400VAC(Y) O/P: FULL LOAD Ta: 25°C | PF=0.994/230VAC(Δ) PF=0.99/400VAC(Y) | | | | | | | | | | | | | | | | | | | | | | | | | | | | | | | |
| | | | P.F vs LOAD <table border="1"> <caption>P.F vs LOAD Data</caption> <thead> <tr> <th>Load (%)</th> <th>230VAC P.F</th> <th>400VAC P.F</th> </tr> </thead> <tbody> <tr><td>10%</td><td>0.90</td><td>0.89</td></tr> <tr><td>20%</td><td>0.94</td><td>0.93</td></tr> <tr><td>30%</td><td>0.96</td><td>0.95</td></tr> <tr><td>40%</td><td>0.97</td><td>0.96</td></tr> <tr><td>50%</td><td>0.98</td><td>0.97</td></tr> <tr><td>60%</td><td>0.985</td><td>0.975</td></tr> <tr><td>70%</td><td>0.99</td><td>0.98</td></tr> <tr><td>80%</td><td>0.992</td><td>0.985</td></tr> <tr><td>90%</td><td>0.994</td><td>0.988</td></tr> <tr><td>100%</td><td>0.994</td><td>0.988</td></tr> </tbody> </table> | | | Load (%) | 230VAC P.F | 400VAC P.F | 10% | 0.90 | 0.89 | 20% | 0.94 | 0.93 | 30% | 0.96 | 0.95 | 40% | 0.97 | 0.96 | 50% | 0.98 | 0.97 | 60% | 0.985 | 0.975 | 70% | 0.99 | 0.98 | 80% | 0.992 | 0.985 | 90% | 0.994 | 0.988 |
| Load (%) | 230VAC P.F | 400VAC P.F | | | | | | | | | | | | | | | | | | | | | | | | | | | | | | | | | |
| 10% | 0.90 | 0.89 | | | | | | | | | | | | | | | | | | | | | | | | | | | | | | | | | |
| 20% | 0.94 | 0.93 | | | | | | | | | | | | | | | | | | | | | | | | | | | | | | | | | |
| 30% | 0.96 | 0.95 | | | | | | | | | | | | | | | | | | | | | | | | | | | | | | | | | |
| 40% | 0.97 | 0.96 | | | | | | | | | | | | | | | | | | | | | | | | | | | | | | | | | |
| 50% | 0.98 | 0.97 | | | | | | | | | | | | | | | | | | | | | | | | | | | | | | | | | |
| 60% | 0.985 | 0.975 | | | | | | | | | | | | | | | | | | | | | | | | | | | | | | | | | |
| 70% | 0.99 | 0.98 | | | | | | | | | | | | | | | | | | | | | | | | | | | | | | | | | |
| 80% | 0.992 | 0.985 | | | | | | | | | | | | | | | | | | | | | | | | | | | | | | | | | |
| 90% | 0.994 | 0.988 | | | | | | | | | | | | | | | | | | | | | | | | | | | | | | | | | |
| 100% | 0.994 | 0.988 | | | | | | | | | | | | | | | | | | | | | | | | | | | | | | | | | |
| 4 | EFFICIENCY (TYP) | 90.5% | I/P: 230 VAC(Δ) I/P: 400VAC(Y) O/P: FULL LOAD Ta: 25°C | 90.51%/230VAC (Δ) 90.53%/400VAC(Y) | | | | | | | | | | | | | | | | | | | | | | | | | | | | | | | |
| | | | EFFICIENCY vs LOAD | | | | | | | | | | | | | | | | | | | | | | | | | | | | | | | | |

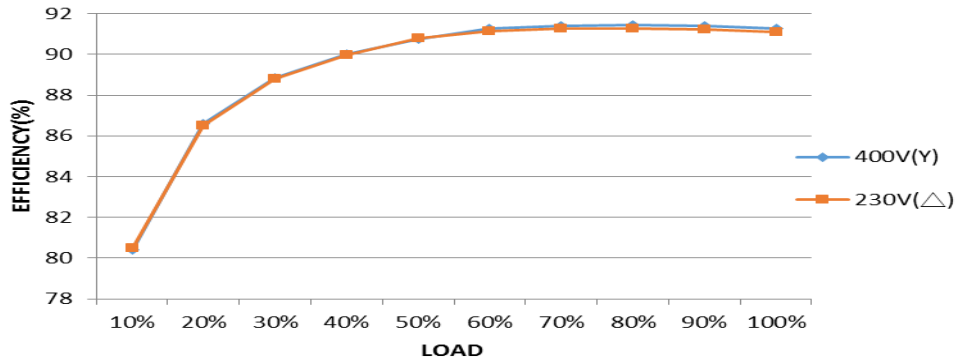

| | | | | |
|---|---------------------|--|--|--|
| 5 | INPUT CURRENT (Typ) | 230V (3 Φ △)/ 30A 400V(3 Φ Y)/ 18A | I/P: 230 VAC(△) I/P:400VAC(Y) O/P:FULL LOAD Ta:25°C | I =28.49 A/ 230VAC(△) I = 15.73A/ 400VAC(Y) |
| 6 | INRUSH CURRENT(Typ) | 230V/150 A 400V/100 A COLD START | I/P:230VAC(△) I/P:400VAC (Y) O/P:FULL LOAD Ta:25°C | I =106A/230 VAC (△) I =68.5A/ 400VAC (Y) |

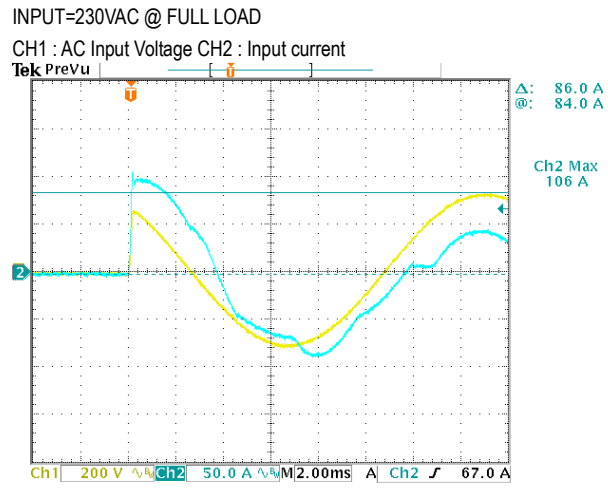
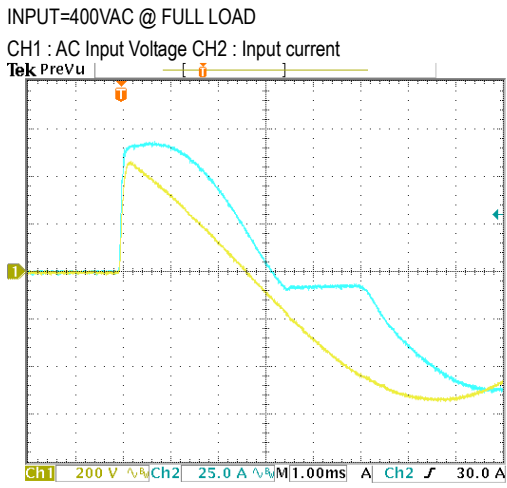

| | | | | |
|---|-----------------|----------------|---|--|
| 7 | LEAKAGE CURRENT | <7mA /305V (△) | I/P:305VAC(△) O/P:NO LOAD Ta:25°C | R-FG:2.8mA S-FG:2.8mA T-FG:2.8mA R,S,T,-V(+):2mA R,S,T-V(-): 2mA |
|---|-----------------|----------------|---|--|

PROTECTION FUNCTION TEST

| NO | TEST ITEM | SPECIFICATION | TEST CONDITION | RESULT | VERDICT |
|----|-----------------------------|--|--|--|---------|
| 1 | OVER LOAD PROTECTION | 100%~112% | I/P: 230VAC(Δ) I/P: 400VAC(Y) O/P: TESTING Ta: 25°C | 105%/230VAC(Δ) 104.85%/400VAC(Y) User adjustable continuous constant current limiting or constant current limiting with delay shutdown after 5 seconds, re-power on to recover | P |
| 2 | OVER VOLTAGE PROTECTION | 60V~67.2V | I/P: 230VAC(Δ) I/P: 400VAC(Y) O/P: MIN LOAD Ta: 25°C | 63.2V/ 230VAC(Δ) 63.2V/400VAC(Y) Shunt down Re- power ON | P |
| 3 | OVER TEMPERATURE PROTECTION | Shut down o/p voltage · recovers automatically after temperature goes down | I/P: 230 VAC(Δ) I/P: 400VAC(Y) O/P: FULL LOAD | Shut down o/p voltage · recovers automatically after temperature goes down | P |
| 4 | SHORT PROTECTION | SHORT EVERY OUTPUT 1 HOUR NO DAMAGE | I/P: 305VAC(Δ) I/P: 530VAC(Y) O/P: FULL LOAD Ta: 25°C | NO DAMAGE constant current limiting with delay shutdown after 5 seconds, re-power on to recover | P |

CONTROL FUNCTION TEST

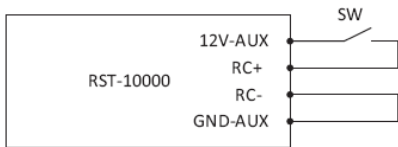
| NO | TEST ITEM | SPECIFICATION | TEST CONDITION | RESULT | | | | | | |
|--|-----------------------|--|---|--|---------------|------------------|--------|----------------|---------|--|
| 1 | AUXILIARY POWER (AUX) | 12V@0.1A Only for Remote ON/OFF Control | I/P: 230 VAC(Δ) I/P: 400VAC(Y) O/P: FULL LOAD Ta: 25°C | 230 VAC(Δ): 11.98 V@0.1A 400VAC(Y): 11.98V@0.1A | | | | | | |
| 2 | Remote ON/OFF Control | <p>The PSU can be turned ON/OFF by using the "Remote ON/OFF" function.</p> <table border="1"> <thead> <tr> <th>Between ON/OFF(CN313 or CN314 pin10) and 12V-AUX(CN315 pin1)</th> <th>Output Status</th> </tr> </thead> <tbody> <tr> <td>SW close (Short)</td> <td>PSU ON</td> </tr> <tr> <td>SW open (Open)</td> <td>PSU OFF</td> </tr> </tbody> </table>  <p>Fig 1.1</p> | | Between ON/OFF(CN313 or CN314 pin10) and 12V-AUX(CN315 pin1) | Output Status | SW close (Short) | PSU ON | SW open (Open) | PSU OFF | |
| Between ON/OFF(CN313 or CN314 pin10) and 12V-AUX(CN315 pin1) | Output Status | | | | | | | | | |
| SW close (Short) | PSU ON | | | | | | | | | |
| SW open (Open) | PSU OFF | | | | | | | | | |
| 3 | REMOTE SENSE | S+ / S- >0.3V | I/P: 400VAC(Y) O/P: FULL LOAD Ta: 25°C | > 0.3 V | | | | | | |

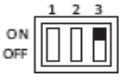
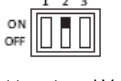
| 4 | OUTPUT VOLTAGE PROGRAMMABLE | <p>I/P: 400VAC(Y)</p>  <p>DIP SW3 ON CN313 PV+ Connect to external V+ CN313 PV- Connect to external V-</p> <table border="1" data-bbox="446 436 901 660"> <thead> <tr> <th>EXT.DC(V)</th> <th>Vo(%)</th> <th>LOAD</th> </tr> </thead> <tbody> <tr><td>DC=1V±0.5%</td><td>20%±3%</td><td>0~100%</td></tr> <tr><td>DC=2V±0.5%</td><td>40%±3%</td><td>0~100%</td></tr> <tr><td>DC=3V±0.5%</td><td>60%±3%</td><td>0~100%</td></tr> <tr><td>DC=4V±0.5%</td><td>80%±3%</td><td>0~100%</td></tr> <tr><td>DC=5V±0.5%</td><td>100%±3%</td><td>0~100%</td></tr> <tr><td>DC=6V±0.5%</td><td>120%±3%</td><td>0~80%</td></tr> </tbody> </table> | EXT.DC(V) | Vo(%) | LOAD | DC=1V±0.5% | 20%±3% | 0~100% | DC=2V±0.5% | 40%±3% | 0~100% | DC=3V±0.5% | 60%±3% | 0~100% | DC=4V±0.5% | 80%±3% | 0~100% | DC=5V±0.5% | 100%±3% | 0~100% | DC=6V±0.5% | 120%±3% | 0~80% | <table border="1" data-bbox="997 380 1356 616"> <thead> <tr> <th>EXT.DC(V)</th> <th>Vo(%)</th> <th>LOAD</th> </tr> </thead> <tbody> <tr><td>DC=1V</td><td>20.5%~20.3%</td><td>0~100%</td></tr> <tr><td>DC=2V</td><td>40.02%~39.8%</td><td>0~100%</td></tr> <tr><td>DC=3V</td><td>60.08%~59.66%</td><td>0~100%</td></tr> <tr><td>DC=4V</td><td>81.07%~80.66%</td><td>0~100%</td></tr> <tr><td>DC=5V</td><td>99.71%~99.23%</td><td>0~100%</td></tr> <tr><td>DC=6V</td><td>119.3%~119.5%</td><td>0~80%</td></tr> </tbody> </table> | EXT.DC(V) | Vo(%) | LOAD | DC=1V | 20.5%~20.3% | 0~100% | DC=2V | 40.02%~39.8% | 0~100% | DC=3V | 60.08%~59.66% | 0~100% | DC=4V | 81.07%~80.66% | 0~100% | DC=5V | 99.71%~99.23% | 0~100% | DC=6V | 119.3%~119.5% | 0~80% |
|-------------------|--|---|---|---------------|-------------|---------------|--|----------------|-----------------------------------|-------------|--------|--|----------------|---------------|------------|----------|--------|------------|-------------------|--------|---|-----------|--------------|---|-----------|--------|--------|-------|-------------|--------|-------|--------------|--------|-------|---------------|--------|-------|---------------|--------|-------|---------------|--------|-------|---------------|-------|
| EXT.DC(V) | Vo(%) | LOAD | | | | | | | | | | | | | | | | | | | | | | | | | | | | | | | | | | | | | | | | | | | |
| DC=1V±0.5% | 20%±3% | 0~100% | | | | | | | | | | | | | | | | | | | | | | | | | | | | | | | | | | | | | | | | | | | |
| DC=2V±0.5% | 40%±3% | 0~100% | | | | | | | | | | | | | | | | | | | | | | | | | | | | | | | | | | | | | | | | | | | |
| DC=3V±0.5% | 60%±3% | 0~100% | | | | | | | | | | | | | | | | | | | | | | | | | | | | | | | | | | | | | | | | | | | |
| DC=4V±0.5% | 80%±3% | 0~100% | | | | | | | | | | | | | | | | | | | | | | | | | | | | | | | | | | | | | | | | | | | |
| DC=5V±0.5% | 100%±3% | 0~100% | | | | | | | | | | | | | | | | | | | | | | | | | | | | | | | | | | | | | | | | | | | |
| DC=6V±0.5% | 120%±3% | 0~80% | | | | | | | | | | | | | | | | | | | | | | | | | | | | | | | | | | | | | | | | | | | |
| EXT.DC(V) | Vo(%) | LOAD | | | | | | | | | | | | | | | | | | | | | | | | | | | | | | | | | | | | | | | | | | | |
| DC=1V | 20.5%~20.3% | 0~100% | | | | | | | | | | | | | | | | | | | | | | | | | | | | | | | | | | | | | | | | | | | |
| DC=2V | 40.02%~39.8% | 0~100% | | | | | | | | | | | | | | | | | | | | | | | | | | | | | | | | | | | | | | | | | | | |
| DC=3V | 60.08%~59.66% | 0~100% | | | | | | | | | | | | | | | | | | | | | | | | | | | | | | | | | | | | | | | | | | | |
| DC=4V | 81.07%~80.66% | 0~100% | | | | | | | | | | | | | | | | | | | | | | | | | | | | | | | | | | | | | | | | | | | |
| DC=5V | 99.71%~99.23% | 0~100% | | | | | | | | | | | | | | | | | | | | | | | | | | | | | | | | | | | | | | | | | | | |
| DC=6V | 119.3%~119.5% | 0~80% | | | | | | | | | | | | | | | | | | | | | | | | | | | | | | | | | | | | | | | | | | | |
| 5 | OUTPUT CURRENT PROGRAMMABLE | <p>I/P: 400VAC(Y)</p>  <p>DIP SW2 ON CN313 PC+ Connect to external V+ CN313 PC- Connect to external V-</p> <table border="1" data-bbox="446 862 901 1064"> <thead> <tr> <th>EXT.DC(V)</th> <th>Io_limit (%)</th> <th>LOAD</th> </tr> </thead> <tbody> <tr><td>DC=1V±0.5%</td><td>20%±10%</td><td>0~100%</td></tr> <tr><td>DC=2V±0.5%</td><td>40%±10%</td><td>0~100%</td></tr> <tr><td>DC=3V±0.5%</td><td>60%±10%</td><td>0~100%</td></tr> <tr><td>DC=4V±0.5%</td><td>80%±10%</td><td>0~100%</td></tr> <tr><td>DC=5V±0.5%</td><td>100%±10%</td><td>0~100%</td></tr> </tbody> </table> | EXT.DC(V) | Io_limit (%) | LOAD | DC=1V±0.5% | 20%±10% | 0~100% | DC=2V±0.5% | 40%±10% | 0~100% | DC=3V±0.5% | 60%±10% | 0~100% | DC=4V±0.5% | 80%±10% | 0~100% | DC=5V±0.5% | 100%±10% | 0~100% | <table border="1" data-bbox="997 784 1412 985"> <thead> <tr> <th>EXT.DC(V)</th> <th>Io_limit (%)</th> <th>LOAD</th> </tr> </thead> <tbody> <tr><td>DC=1V</td><td>20.90%</td><td>0~100%</td></tr> <tr><td>DC=2V</td><td>41.23%</td><td>0~100%</td></tr> <tr><td>DC=3V</td><td>60.52%</td><td>0~100%</td></tr> <tr><td>DC=4V</td><td>80.23%</td><td>0~100%</td></tr> <tr><td>DC=5V</td><td>100.57%</td><td>0~100%</td></tr> </tbody> </table> | EXT.DC(V) | Io_limit (%) | LOAD | DC=1V | 20.90% | 0~100% | DC=2V | 41.23% | 0~100% | DC=3V | 60.52% | 0~100% | DC=4V | 80.23% | 0~100% | DC=5V | 100.57% | 0~100% | | | | | | |
| EXT.DC(V) | Io_limit (%) | LOAD | | | | | | | | | | | | | | | | | | | | | | | | | | | | | | | | | | | | | | | | | | | |
| DC=1V±0.5% | 20%±10% | 0~100% | | | | | | | | | | | | | | | | | | | | | | | | | | | | | | | | | | | | | | | | | | | |
| DC=2V±0.5% | 40%±10% | 0~100% | | | | | | | | | | | | | | | | | | | | | | | | | | | | | | | | | | | | | | | | | | | |
| DC=3V±0.5% | 60%±10% | 0~100% | | | | | | | | | | | | | | | | | | | | | | | | | | | | | | | | | | | | | | | | | | | |
| DC=4V±0.5% | 80%±10% | 0~100% | | | | | | | | | | | | | | | | | | | | | | | | | | | | | | | | | | | | | | | | | | | |
| DC=5V±0.5% | 100%±10% | 0~100% | | | | | | | | | | | | | | | | | | | | | | | | | | | | | | | | | | | | | | | | | | | |
| EXT.DC(V) | Io_limit (%) | LOAD | | | | | | | | | | | | | | | | | | | | | | | | | | | | | | | | | | | | | | | | | | | |
| DC=1V | 20.90% | 0~100% | | | | | | | | | | | | | | | | | | | | | | | | | | | | | | | | | | | | | | | | | | | |
| DC=2V | 41.23% | 0~100% | | | | | | | | | | | | | | | | | | | | | | | | | | | | | | | | | | | | | | | | | | | |
| DC=3V | 60.52% | 0~100% | | | | | | | | | | | | | | | | | | | | | | | | | | | | | | | | | | | | | | | | | | | |
| DC=4V | 80.23% | 0~100% | | | | | | | | | | | | | | | | | | | | | | | | | | | | | | | | | | | | | | | | | | | |
| DC=5V | 100.57% | 0~100% | | | | | | | | | | | | | | | | | | | | | | | | | | | | | | | | | | | | | | | | | | | |
| 6 | Select OLP mode | <table border="1" data-bbox="606 1108 1348 1198"> <thead> <tr> <th>SW301</th> <th>PROTECTION</th> </tr> </thead> <tbody> <tr> <td>SW970 PIN1 ON</td> <td>Constant current delay 5sec Vo shutdown repower on</td> </tr> <tr> <td>SW970 PIN1 OFF</td> <td>Constant current</td> </tr> </tbody> </table> | | SW301 | PROTECTION | SW970 PIN1 ON | Constant current delay 5sec Vo shutdown repower on | SW970 PIN1 OFF | Constant current | | | | | | | | | | | | | | | | | | | | | | | | | | | | | | | | | | | | |
| SW301 | PROTECTION | | | | | | | | | | | | | | | | | | | | | | | | | | | | | | | | | | | | | | | | | | | | |
| SW970 PIN1 ON | Constant current delay 5sec Vo shutdown repower on | | | | | | | | | | | | | | | | | | | | | | | | | | | | | | | | | | | | | | | | | | | | |
| SW970 PIN1 OFF | Constant current | | | | | | | | | | | | | | | | | | | | | | | | | | | | | | | | | | | | | | | | | | | | |
| 7 | Front Panel Indicators | <table border="1" data-bbox="446 1232 949 1332"> <thead> <tr> <th>LED</th> <th>Description</th> </tr> </thead> <tbody> <tr> <td>GREEN(LED1)</td> <td>LED on when output voltage is OK</td> </tr> <tr> <td>RED(LED2)</td> <td>LED on when any protection occurs</td> </tr> </tbody> </table> | | LED | Description | GREEN(LED1) | LED on when output voltage is OK | RED(LED2) | LED on when any protection occurs | | | | | | | | | | | | | | | | | | | | | | | | | | | | | | | | | | | | |
| LED | Description | | | | | | | | | | | | | | | | | | | | | | | | | | | | | | | | | | | | | | | | | | | | |
| GREEN(LED1) | LED on when output voltage is OK | | | | | | | | | | | | | | | | | | | | | | | | | | | | | | | | | | | | | | | | | | | | |
| RED(LED2) | LED on when any protection occurs | | | | | | | | | | | | | | | | | | | | | | | | | | | | | | | | | | | | | | | | | | | | |
| 8 | FAN LOCK TEST | <p>I/P: 400VAC(Y) O/P: FULL LOAD Ta: 25°C</p> | Shut down Re-power ON | | | | | | | | | | | | | | | | | | | | | | | | | | | | | | | | | | | | | | | | | | |
| 9 | AC- FAIL | <p>I/P: 400VAC(Y) O/P: NO LOAD</p> <table border="1" data-bbox="446 1534 941 1624"> <thead> <tr> <th>Test condition</th> <th>Input Voltage</th> <th>STATE</th> </tr> </thead> <tbody> <tr> <td>Low Line</td> <td>316±7Vac(Y)</td> <td>AC Fail</td> </tr> <tr> <td>Low Line recovery</td> <td>332±5Vac(Y)</td> <td>OK</td> </tr> </tbody> </table> <p>Ta: 25°C</p> | Test condition | Input Voltage | STATE | Low Line | 316±7Vac(Y) | AC Fail | Low Line recovery | 332±5Vac(Y) | OK | <table border="1" data-bbox="981 1456 1380 1601"> <thead> <tr> <th>Test condition</th> <th>Input Voltage</th> <th>STATE</th> </tr> </thead> <tbody> <tr> <td>Low Line</td> <td>314.7</td> <td>AC Fail</td> </tr> <tr> <td>Low Line recovery</td> <td>332.72</td> <td>OK</td> </tr> </tbody> </table> | Test condition | Input Voltage | STATE | Low Line | 314.7 | AC Fail | Low Line recovery | 332.72 | OK | | | | | | | | | | | | | | | | | | | | | | | | |
| Test condition | Input Voltage | STATE | | | | | | | | | | | | | | | | | | | | | | | | | | | | | | | | | | | | | | | | | | | |
| Low Line | 316±7Vac(Y) | AC Fail | | | | | | | | | | | | | | | | | | | | | | | | | | | | | | | | | | | | | | | | | | | |
| Low Line recovery | 332±5Vac(Y) | OK | | | | | | | | | | | | | | | | | | | | | | | | | | | | | | | | | | | | | | | | | | | |
| Test condition | Input Voltage | STATE | | | | | | | | | | | | | | | | | | | | | | | | | | | | | | | | | | | | | | | | | | | |
| Low Line | 314.7 | AC Fail | | | | | | | | | | | | | | | | | | | | | | | | | | | | | | | | | | | | | | | | | | | |
| Low Line recovery | 332.72 | OK | | | | | | | | | | | | | | | | | | | | | | | | | | | | | | | | | | | | | | | | | | | |
| 10 | CURRENT SHARING | <p>PSU1-PSU2 < 10%</p> | <p>I/P: 400VAC(Y) O/P : 90%/L/50% LOAD Ta : 25°C</p> <p>O/P : 100% PSU1 : 213.5 A PSU2 : 209.3 A</p> <p>O/P : 50% PSU1 : 106.5 A PSU2 : 104.2 A</p> | | | | | | | | | | | | | | | | | | | | | | | | | | | | | | | | | | | | | | | | | | |
| 11 | Alarm Signal Output | <p>There are 4 alarm signals on CN315, and each signal can select two types of output circuit. (1) Relay contact output Normally open contact. "Short" when the alarm arises. Relay contact rating(maximum) is 30V/1A resistive.</p> | | | | | | | | | | | | | | | | | | | | | | | | | | | | | | | | | | | | | | | | | | | |

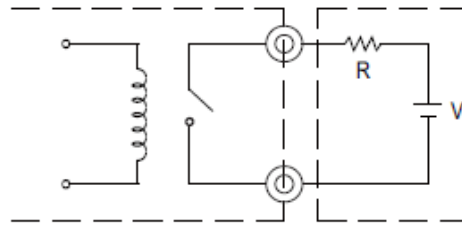

(2)Open collector output

Normally open contact. "Short" when the alarm arises. Relay contact rating(maximum) is 30V/1A resistive. An external voltage source is required for this function that is shown in Fig 7.2. These signals are isolated from output. The maximum sink current is 10mA and the maximum external voltage is 20V (there is a built-in 24V zener diode in inner circuitry).

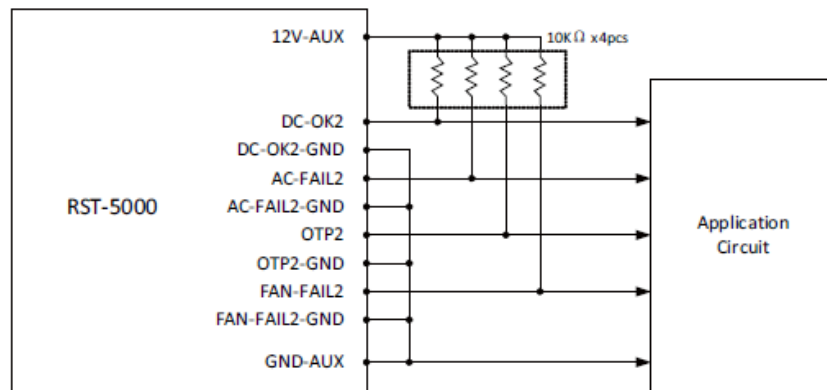

TEST CONDITION :

I/P: 400VAC(Y)
O/P:FULL LOAD
Ta:25°C

RESULT:

| Function | Description |
|--|---|
| DC- OK 1: AC-FAIL 1 FAN -FAIL 1 OTP 1 | Alarm signal of AC-fail. Normally open contact. "Short" when the PSU input voltage is too low. Relay contact rating(maximum) is 30V/1A resistive. |
| DC- OK 2: AC-FAIL 2 FAN -FAIL 2 OTP 2 | Alarm signal of AC fail. Open collector signal. Low when the PSU input voltage is too low. The maximum sink current is 10mA and the maximum external voltage is 20V. |

COMPONENT STRESS TEST

| NO | TEST ITEM | SPECIFICATION | TEST CONDITION | RESULT |
|----|--|-------------------------|--|-------------------------------|
| 1 | PWM Transistor (D to S) or (C to E) Peak Voltage | Q124 Rated 38 A/600V | I/P:High-Line =533V(Y) O/P: (1)Full Load input on/off (2)Output Short (3)Dynamic Load Full Load/ Min. Load 90%Duty/1KHz Ta:25°C | (1)428V (2)454V (3)446V |

| | | | | |
|---|--|--|--|---------------------------------------|
| 2 | Diode Peak Voltage | D452 Rated 200A/200V | I/P:High-Line =533 V (Y) O/P: (1)Full Load input on/off (2)Output Short (3)Dynamic Load Full Load/ Min. Load 90%Duty/1KHz Ta:25°C | (1)172V (2)142V (3)173V |
| 3 | Input Capacitor Voltage | C2 Rated: 470 μ /450 SURGE VOLTAGE :495V | I/P:High-Line =533 V (Y) O/P: (1)Full Load input on/off (2) Min load input on /Off (3)Full Load /Min load Change Ta:25°C | (1)462V (2)460V (3)450V |
| 4 | Control IC Voltage Test | U302 Rated 9.8~18.5V | I/P:High-Line =533 V (Y) O/P:(1)FULL LOAD (2) Output Short Ta:25°C | (1)12.8V (2)12.4V 1. |
| 5 | P.F.C Transistor (D to S) or (C to E) Peak Voltage | Q2 Rated 47A/ 600V | I/P:High-Line =533 V (Y) O/P: (1)Full Load input on/off (2)Output Short (3)Dynamic Load Full Load/ Min. Load 90%Duty/1KHz Ta:25°C | (1)544 V (2)530 V (3)506 V ● |

● **SAFETY & E.M.C. TEST**

SAFETY TEST

| NO | TEST ITEM | SPECIFICATION | TEST CONDITION | RESULT |
|----|----------------------|--|--|---|
| 1 | WITHSTAND VOLTAGE | I/P-O/P : 3 KVAC/min I/P-FG : 2KVAC/min O/P-FG : 0.5 KVAC/min | I/P-O/P : 3.6 KVAC/min I/P-FG : 2.4KVAC/min O/P-FG : 0.6 KVAC/min Ta : 25°C | I/P-O/P : 28.63 mA I/P-FG : 22.54 mA O/P-FG : 12.6 mA NO DAMAGE |
| 2 | ISOLATION RESISTANCE | I/P-O/P : 500VDC>100M Ω I/P-FG : 500VDC>100M Ω O/P-FG : 500VDC>100M Ω | I/P-O/P : 500 VDC I/P-FG : 500 VDC O/P-FG : 500 VDC Ta : 25°C/70% RH | I/P-O/P : 160 M Ω I/P-FG : 10.6 G Ω O/P-FG : 11.5 G Ω NO DAMAGE |
| 3 | GROUNDING CONTINUITY | FG(PE) TO CHASSIS OR TRACE < 100 m Ω | 40 A / 2min Ta : 25°C /70% RH | 6 m Ω |

E.M.C TEST

| NO | TEST ITEM | SPECIFICATION | TEST CONDITION | RESULT |
|----|------------|------------------------|---|-----------------------|
| 1 | HARMONIC | EN61000-3-2 CLASS A | I/P: 400VAC(50HZ) (Y) O/P:100%,LOAD Ta:25°C | PASS |
| 2 | CONDUCTION | EN55022 CLASS A | I/P: 400VAC(50HZ) (Y) O/P:FULL/50% LOAD Ta:25°C | Test by certified Lab |
| 3 | RADIATION | EN55022 CLASS A | I/P: 400VAC(50HZ) (Y) O/P:FULL LOAD Ta:25°C | Test by certified Lab |



| | | | | |
|---|---|--|---|------------|
| 4 | E.S.D | EN61000-4-2 INDUSTRY AIR:8KV / Contact:4KV | I/P: 400VAC(50HZ) (Y) O/P:FULL LOAD Ta:25°C | CRITERIA A |
| 5 | E.F.T | EN61000-4-4 INDUSTRY INPUT: 2KV | I/P: 400VAC(50HZ) (Y) O/P:FULL LOAD Ta:25°C | CRITERIA A |
| 6 | SURGE | IEC61000-4-5 INDUSTRY L-N :2KV L,N-PE:4KV | I/P: 400VAC(50HZ) (Y) O/P:FULL LOAD Ta:25°C | CRITERIA A |
| 7 | Test by certified Lab & Test Report Prepare | | | |

■ RELIABILITY TEST

ENVIRONMENT TEST

| NO | TEST ITEM | SPECIFICATION | TEST CONDITION | RESULT |
|----|-----------------------|--|----------------|--------|
| 1 | TEMPERATURE RISE TEST | MODEL : RST-10000-24 1. ROOM AMBIENT BURN-IN : 2 HRS I/P : 400VAC(Y) O/P : FULL LOAD Ta= 38 °C 2. HIGH AMBIENT BURN-IN : 2 HRS I/P : 400VAC(Y) O/P : FULL LOAD Ta= 48 °C | | |

| | | NO | Position | ROOM AMBIENT Ta= 38 °C | HIGH AMBIENT Ta= 48 °C |
|---|---|---|----------|--|------------------------|
| | | 1 | Q151 | 68.8°C | 80.5°C |
| | | 2 | Q126 | 67.8°C | 79.0°C |
| | | 3 | D3 | 75.5°C | 85.6°C |
| | | 4 | D43 | 83.6°C | 93.4°C |
| | | 5 | Q3 | 73.0°C | 83.5°C |
| | | 6 | Q43 | 84.9°C | 94.0°C |
| | | 7 | BD1 | 87.4°C | 97.4°C |
| | | 8 | BD41 | 93.9°C | 103.3°C |
| | | 9 | L1 | 58.2°C | 68.6°C |
| | | 10 | C1 | 55.0°C | 65.0°C |
| | | 11 | T123 | 57.8°C | 66.5°C |
| | | 12 | L121 | 73.6°C | 84.9°C |
| | | 13 | D452 | 106.4°C | 115.2°C |
| | | 14 | NTC | 57.4°C | 67.8°C |
| | | 15 | T451 | 88.1°C | 99.3°C |
| | | 16 | T452 | 92.2°C | 102.1°C |
| | | 17 | T453 | 80.8°C | 91.9°C |
| | | 18 | D456 | 58.4°C | 68.9°C |
| | | 19 | L452 | 69.1°C | 80.9°C |
| | | 20 | Q640 | 46.5°C | 56.7°C |
| | | 21 | C647 | 43.2°C | 61.2°C |
| | | 22 | C602 | 52.8°C | 62.6°C |
| | | 23 | C621 | 54.6°C | 64.9°C |
| | | 24 | RG603 | 57.4°C | 79.2°C |
| | | 25 | D148 | 62.1°C | 74.3°C |
| | | 26 | C122 | 56.4°C | 66.8°C |
| | | 27 | C146 | 57.0°C | 67.4°C |
| | | 28 | TSW1 | 75.2°C | 85.1°C |
| | | 29 | C465 | 58.5°C | 69.6°C |
| 2 | OVER LOAD BURN-IN TEST | NO DAMAGE 1 HOUR (MIN) | | I/P : 400VAC(Y) O/P : 104 % LOAD Ta : 25°C | TEST : OK |
| 3 | LOW TEMPERATURE TURN ON TEST | TURN ON AFTER 2 HOUR | | I/P : 230VAC/196VAC(Δ) O/P : 100 % LOAD Ta= -35 °C | TEST : OK |
| 4 | HIGH HUMIDITY HIGH TEMPERATURE HIGH VOLTAGE TURN ON TEST | AFTER 12 HOURS IN CHAMBER ON CONTROL 50 °C NO DAMAGE | | I/P : 540VAC(Δ) O/P : FULL LOAD Ta= 50 °C HUMIDITY= 95 %R.H | TEST : OK |
| 5 | TEMPERATURE COEFFICIENT | ± 0.03 %(0~50°C) | | I/P : 230 VAC(Δ) O/P : FULL LOAD | ± 0.022 %(0~50°C) |
| 6 | STORAGE TEMPERATURE TEST | 1. Thermal shock Temperature : -45°C~ +90°C 2. Temperature change rate : 25°C / MIN 3. Dwell time low and high temperature : 30 MIN/EACH 4. Total test cycle : 5 CYCLE 5. Input/Output condition : STATIC | | | OK |



| | | | |
|----|-----------------------------|---|---|
| 7 | THERMAL SHOCK TEST | 1. Thermal shock Temperature : -35°C ~ +55°C 2. Temperature change rate : 25°C / MIN 3. Dwell time low and high temperature : 30 MIN/EACH 4. Total test cycle : 10 CYCLE 5. Input/Output condition : 230VAC(Δ)/Full Load | OK |
| 8 | VIBRATION TEST | 1 Carton & 1 Set (1) Waveform : Sine Wave (2) Frequency : 10~500Hz (3) Sweep Time : 12min/sweep cycle (4) Acceleration : 2G (5) Test Time : 60min in each axis (X.Y.Z) (6) Ta : 25°C | TEST : OK |
| 9 | CAPACITOR LIFE CYCLE | SUPPOSE C453 IS THE MOST CRITICAL COMPONENT (1) I/P : 400VAC(Y) O/P : FULL LOAD Ta= 25 °C LIFE TIME (2) I/P : 400VAC(Y) O/P : FULL LOAD Ta= 50 °C LIFE TIME (3) I/P : 400VAC(Y) O/P : 75% LOAD Ta= 50 °C LIFE TIME (4) I/P : 400VAC(Y) O/P : 50% LOAD Ta= 50 °C LIFE TIME | (1) 1844214 HRS (2) 306284 HRS (3) 384999 HRS (4) 433136 HRS |
| 10 | MTBF | Conducted by Parts Stress Analysis Prediction 147.5K hrs min. Telcordia SR-332 (Bellcore) ; 17.1K hrs min. MIL-HDBK-217F (25°C) | |
| 11 | DMTBF/Accelerated Life Test | Demonstration Mean Time Between Failure (Expected Life): Above 50,000 hours @ TA 50°C | |

| SAMPLE | TESTER | REVIEW | APPROVAL |
|----------------|------------|------------|--------------|
| Product sample | DANIEL GAO | SANFORD SU | VINCENT ZENG |

12.10.30 A50-F031